



DATA SHEET

SKY65346-21: 900 MHz Transmit/Receive Front-End Module

Applications

- Automated meter reading

Features

- Externally available bias circuits
- Control logic
- Cascaded receive gain: 12.4 dB
- Cascaded Noise Figure: 2.4 dB
- Transmit power: +26 dBm
- Single DC supply
- Shutdown mode
- Small, MCM (26-pin, 5 x 5 mm) package (MSL3, 260 °C per JEDEC J-STD-020)



Skyworks Green™ products are compliant with all applicable legislation and are halogen-free. For additional information, refer to *Skyworks Definition of Green™*, document number SQ04-0074.

Description

The SKY65346-21 is a high performance transmit/receive (T/R) Front-End Module (FEM) ideally suited for use in 900 MHz Industrial, Scientific, and Medical (ISM) applications.

A double-pole, double-throw (DPDT) switch allows the device to select between two antenna ports (ANT1 and ANT2 pins) for the transmit or receive path. A single-pole, double-throw (SPDT) switch selects which signal path is routed to the transceiver port (RFIO pin). The receive path has a Low-Noise Amplifier (LNA) bypass switch.

The Power Amplifier (PA) and LNA biasing can be independently controlled with an external bias resistor. The device has a shutdown mode to minimize power consumption. All eight operating modes are controlled using three digital input pins (CTL1, CTL2, and CTL3).

The SKY65346-21 T/R FEM is provided in a compact, 26-pin 5 x 5 mm Multi-Chip Module (MCM). A functional block diagram is shown in Figure 1. The pin configuration and package are shown in Figure 2. Signal pin assignments and functional pin descriptions are provided in Table 1.

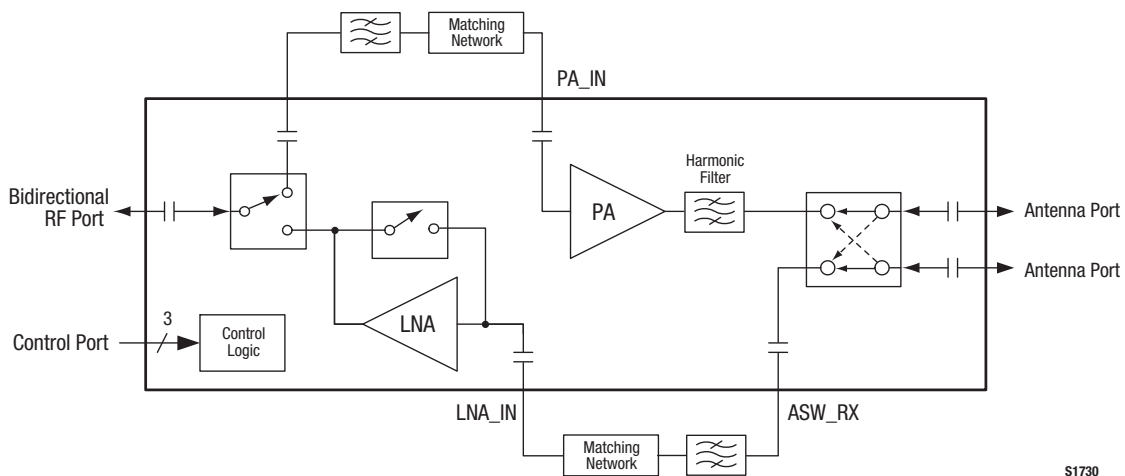
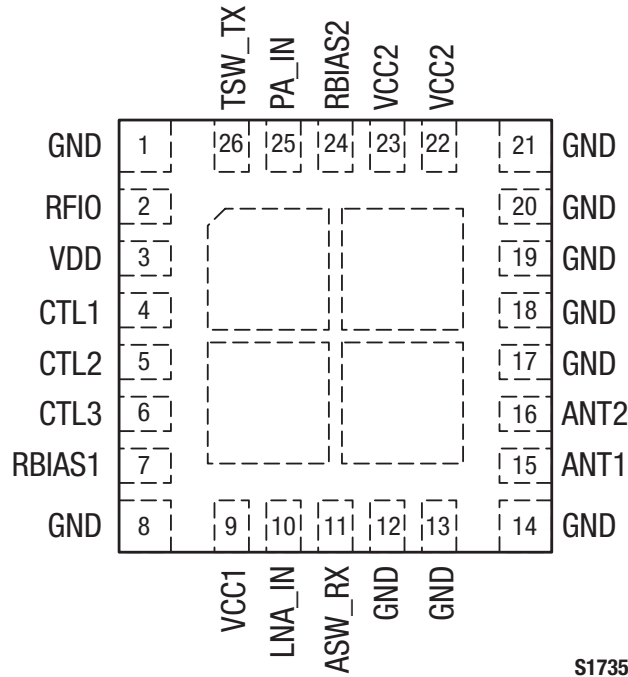

Figure 1. SKY65346-21 Block Diagram



S1735

Figure 2. SKY65346-21 Pinout – 26-Pin MCM (Top View)

Table 1. SKY65346-21 Signal Descriptions

Pin #	Name	Description	Pin #	Name	Description
1	GND	Ground	14	GND	Ground
2	RFIO	RF transceiver port	15	ANT1	Antenna port
3	VDD	Digital power supply	16	ANT2	Antenna port
4	CTL1	Digital control line	17	GND	Ground
5	CTL2	Digital control line	18	GND	Ground
6	CTL3	Digital control line	19	GND	Ground
7	RBIAS1	LNA external bias resistor	20	GND	Ground
8	GND	Ground	21	GND	Ground
9	VCC1	LNA power supply	22	VCC2	PA power supply
10	LNA_IN	LNA input port. Internally matched to 50 Ω.	23	VCC2	PA power supply
11	ASW_RX	Antenna switch receive port	24	RBIAS2	PA external bias resistor
12	GND	Ground	25	PA_IN	PA input port
13	GND	Ground	26	TSW_TX	Transceiver switch transmit port

Functional Description

The SKY65346-21 provides input and output amplifier stages, and is internally matched for optimum efficiency. An active bias circuit provides both input and output stages with excellent gain tracking over temperature and voltage variations. The module operates with positive DC voltages, and maintains high efficiency and good linearity. The nominal operating voltage is 3.3 V for maximum power. The PA and LNA biasing can be independently controlled with an external bias resistor.

Operational Modes

By using three control signals (CTRL1, CTRL2, and CTRL3), the SKY65346-21 can be configured to one of eight operational modes:

- Receive ANT1 bypass. In this mode, a low-loss broadband, bidirectional RF path allows easy switching of the signal between the transceiver and antenna port 1.
- Receive ANT2 bypass. In this mode, a low-loss broadband, bidirectional RF path allows easy switching of the signal between the transceiver and antenna port 2.
- Receive ANT1. In this mode, the SKY65346-21 amplifies the received signal at antenna port 1 through the LNA.

- Receive ANT2. In this mode, the SKY65346-21 amplifies the received signal at antenna port 2 through the LNA.
- Transmit ANT1. In this mode, the transmit path provides an harmonic filter and high efficiency PA on the Antenna 1 Port.
- Transmit ANT2. This is the same mode of operation as Transmit ANT1 except that the output is the Antenna 2 Port.
- Shut down. In this mode, the PA and LNA are powered down for minimal current consumption and low leakage current (<1 μ A).

Table 2 provides the control logic for each of the eight operational modes.

Electrical and Mechanical Specifications

The absolute maximum ratings of the SKY65346-21 are provided in Table 3 and the recommended operating conditions in Table 4. Electrical characteristics for the SKY65346-21 are provided in Table 5 through Table 10.

Typical performance characteristics of the SKY65346-21 are illustrated in Figures 3 through 27.

Table 2. SKY65346-21 Truth Table

Operation Mode	Control Voltage (Note 1)			Internal States				
	CTL1 (Pin 4)	CTL2 (Pin 5)	CTL3 (Pin 6)	LNA On	PA On	RFIO Switch	ANT1 Switch	ANT2 Switch
Receive ANT1 bypass	1	1	1	off	off	Receive LNA	ASW_RX	Transmit PA
Receive ANT2 bypass	1	1	0				Transmit PA	ASW_RX
Receive ANT1	1	0	1	on	off		ASW_RX	Transmit PA
Receive ANT2	1	0	0				Transmit PA	ASW_RX
Transmit ANT1	0	1	1	off	on	TSW_TX	ASW_RX	Transmit PA
Transmit ANT2	0	1	0				ASW_RX	Transmit PA
Shut down	0	0	0		off	off	open	open
Shut down (Note 2)	0	0	1	off	off	open	open	open

Note 1: See Table 4 for logic 0 and logic 1 characteristics.

Note 2: In the high state, the CTL3 pin has an input current of 33 μ A due to an internal 100 k Ω pulldown. This mode is not recommended for lowest leakage current.

Table 3. SKY65346-21 Absolute Maximum Ratings (Note 1)

Parameter	Symbol	Minimum	Maximum	Units
LNA supply voltage (VCC1)	V _{CC1}	-0.3	+5.0	V
PA supply voltage (VCC2)	V _{CC2}	-0.3	+5.0	V
Digital supply voltage (VDD)	V _{DD}	-0.5	4.6	V
Digital input voltage (CTL1, CTL2, CTL3)	V _{CTL}	-0.5	V _{DD} + 0.3	V
LNA supply current (VCC1)	I _{CC1}		20	mA
PA supply current (VCC2)	I _{CC2}		500	mA
Receive RF input power	P _{IN_LNA}		+10	dBm
Transmit RF input power	P _{IN_PA}		+10	dBm
Antenna port load VSWR (Note 2)			10:1	-
Operating case temperature	T _C	-40	+85	°C
Junction temperature	T _J		+150	°C
Storage case temperature	T _{STG}	-55	+150	°C

Note 1: Exposure to maximum rating conditions for extended periods may reduce device reliability. There is no damage to device with only one parameter set at the limit and all other parameters set at or below their nominal value. Exceeding any of the limits listed here may result in permanent damage to the device.

Note 2: Antenna port load VSWR is limited by voltage. An open load condition will not damage the device.

CAUTION: Although this device is designed to be as robust as possible, Electrostatic Discharge (ESD) can damage this device. This device must be protected at all times from ESD. Static charges may easily produce potentials of several kilovolts on the human body or equipment, which can discharge without detection. Industry-standard ESD precautions should be used at all times.

Table 4. SKY65346-21 Recommended Operating Conditions

Parameter	Symbol	Minimum	Typical	Maximum	Units
LNA supply voltage (VCC1)	V _{CC1}	2.7	3.3	3.7	V
PA supply voltage (VCC2)	V _{CC2}	2.7	3.3	3.7	V
Digital supply voltage (VDD)	V _{DD}	2.7	3.3	3.6	V
Digital input voltage, logic 0 (CTL1, CTL2, CTL3)	V _{CTL}	0		0.2	V
Digital input voltage, logic 1 (CTL1, CTL2, CTL3)	V _{CTL}	V _{DD} - 0.2	V _{DD}	3.6	V
Receive RF input power (ANT1, ANT2)	P _{IN_RX}			-10	dBm
Transmit RF input power (RFIO)	P _{IN_TX}	-10	-6	+2	dBm
LNA external bias resistor	R _{BIAS1}	3.3	4.7	33	kΩ
PA external bias resistor	R _{BIAS2}	3.3	12	33	kΩ
915 MHz ISM band frequency range	FB915	902	915	928	MHz

Table 5. SKY65346-21 DC Electrical Specifications (Note 1) (Note 2)
(VCC1 = VCC2 = VDD = 3.3 V, Tc = -40 to +85 °C, f= 928 MHz, CW Input, Unless Otherwise Noted)

Parameter	Symbol	Test Condition	Min	Typical	Max	Units
Quiescent current, receive mode (Note 3)	I _{Q_RX}		5.0	6.7	10.0	mA
Operating current, receive mode (Note 3)	I _{OP_RX}		5.0	6.7	10.0	mA
Quiescent current, transmit mode (Note 3)	I _{Q_TX}		70	78	90	mA
Operating current, transmit mode (Note 3)	I _{OP_TX}	P _{IN} = -6 dBm		223	300	mA
Quiescent current, receive bypass mode (Note 3)	I _{Q_RXB}			75		μA
Quiescent current, shutdown mode (Note 3) (Note 4)	I _{Q_SD}			0.025		μA
Digital input current (Note 4): Logic 1	I _H			33		μA
Logic 0	I _L			0		μA

Note 1: Performance is guaranteed only under the conditions listed in this Table.

Note 2: Parameters are characterized under the conditions noted here and production tested under nominal temperature and voltage conditions with guard-banded limits.

Note 3: Total module power supply current.

Note 4: Shutdown functionality tested in production. Shutdown current (I_{Q_SD}) production tested to be <50 μA.

Table 6. SKY65346-21 Electrical Specifications: LNA_IN to RFIO Receive Path (Note 1) (Note 2) (Note 3)
(VCC1 = VCC2 = VDD = 3.3 V, Tc = -40 to +85 °C, f= 928 MHz, CW Input, Unless Otherwise Noted)

Parameter	Symbol	Test Condition	Min	Typical	Max	Units
Small signal gain	G _{LNA}		10.5	13.7	15.5	dB
Noise Figure	NF _{LNA}	100 kHz bandwidth		1.6	2.4	dB
1 dB input compression point	IP1dB _{LNA}	1 dB gain compression	-13.0	-10.7		dBm
3 rd order input intercept point	IIP3 _{LNA}	400 kHz spacing, P _{IN} = -30 dBm/tone	+6.0	+7.5		dBm
Input return loss	IS11 _{LNA}		10	20		dB
Output return loss	IS22 _{LNA}		10	15		dB
Non-harmonic spurious (Note 4) (Note 5)	P _{SPUR_LNA}	VSWR 10:1, all phases			-50	dBm
LNA_IN to TSW_TX isolation	ISOTSW		9	14		dB

Note 1: Performance is guaranteed only under the conditions listed in this Table.

Note 2: Parameters are characterized under the conditions noted here and production tested under nominal temperature and voltage conditions with guard-banded limits.

Note 3: Receive mode control voltage logic: CTL1, CTL2, and CTL3 = 10xb (refer to Table 2).

Note 4: Parameter is characterized under the conditions listed in this Table, but is not production tested.

Note 5: Measurement performed with P_{IN} = -30 dBm and spectrum analyzer RBW = 100 kHz for frequencies < 1 GHz or RBW = 1 MHz for frequencies from 1 GHz to 10 GHz. Reported spurious maximum value is the noise floor of the spectrum analyzer.

Table 7. SKY65346-21 Electrical Specifications: LNA_IN to RFIO Receive Path – Bypass Mode (Note 1) (Note 2) (Note 3)
(VCC1 = VCC2 = VDD = 3.3 V, Tc = -40 to +85 °C, f= 928 MHz, CW Input, Unless Otherwise Noted)

Parameter	Symbol	Test Condition	Min	Typical	Max	Units
Loss	L _{BYP}			2.5	3.0	dB
1 dB input compression point (Note 4)	IP1dB _{BYP}	1 dB gain compression		+20		dBm
3 rd order input intercept point	IIP3 _{BYP}	400 kHz spacing, P _{IN} = -10 dBm/tone	+16	+21		dBm
Input return loss	IS11 _{BYP}		9.5	12.7		dB
Output return loss	IS22 _{BYP}		7.0	8.2		dB

Note 1: Performance is guaranteed only under the conditions listed in this Table.

Note 2: Parameters are characterized under the conditions noted here and production tested under nominal temperature and voltage conditions with guard-banded limits.

Note 3: Receive mode control voltage logic: CTL1, CTL2, and CTL3 = 11xb (refer to Table 2).

Note 4: Parameter is characterized under the conditions listed in this Table, but is not production tested.

Table 8. SKY65346-21 Electrical Specifications: ANT1/ANT2 to ASW_RX Receive Path (Note 1) (Note 2) (Note 3)
(VCC1 = VCC2 = VDD = 3.3 V, Tc = -40 to +85 °C, f= 928 MHz, CW Input, Unless Otherwise Noted)

Parameter	Symbol	Test Condition	Min	Typical	Max	Units
Switch loss	L _{ANT}			0.8	1.0	dB
1 dB input compression point (Note 4)	IP1dB _{ANT}	1 dB gain compression		+30		dBm
3 rd order input intercept point	IIP3 _{ANT}	400 kHz spacing, P _{IN} = -10 dBm/tone	+44	+47		dBm
Input return loss	IS11 _{ANT}		10	19		dB
Output return loss	IS22 _{ANT}		10	18		dB
ANT1 to ANT2 isolation	ISO _{ANT}		20.5	22.1		dB

Note 1: Performance is guaranteed only under the conditions listed in this Table.

Note 2: Parameters are characterized under the conditions noted here and production tested under nominal temperature and voltage conditions with guard-banded limits.

Note 3: Receive mode control voltage logic: CTL1, CTL2, and CTL3 = 1xxb (refer to Table 2).

Note 4: Parameter is characterized under the conditions listed in this Table, but is not production tested.

Table 9. SKY65346-21 Electrical Specifications: PA_IN to ANT1/ANT2 Transmit Path (Note 1) (Note 2) (Note 3)
(VCC1 = VCC2 = VDD = 3.3 V, Tc = -40 to +85 °C, f= 928 MHz, CW Input, Unless Otherwise Noted)

Parameter	Symbol	Test Condition	Min	Typical	Max	Units
PA small signal gain	G _{TX}		32.0	33.7	37.5	dB
PA saturated output power	P _{SAT}			+26.3		dBm
PA output power	P _{OUT}	P _{IN} = -6 dBm	+24	+25		dBm
Power Added Efficiency	PAE	P _{IN} = -6 dBm		43		%
2 nd harmonic	2f _o	P _{IN} = -6 dBm		-30	-23	dBc
3 rd harmonic	3f _o	P _{IN} = -6 dBm		-55	-50	dBc
4 th harmonic	4f _o	P _{IN} = -6 dBm		-67	-58	dBc
5 th harmonic	5f _o	P _{IN} = -6 dBm		-75	-60	dBc
Input return loss	IS11 TX		9	11		dB
Output return loss	IS22 TX		7	10		dB
Noise Figure	N _{FTX}	100 kHz bandwidth		3.4	7.0	dB
Non-harmonic spurious (Note 4)	P _{SPUR_TX}	VSWR 0:1, all phases			-50	dBm

Note 1: Performance is guaranteed only under the conditions listed in this Table.

Note 2: Parameters are characterized under the conditions noted here and production tested under nominal temperature and voltage conditions with guard-banded limits.

Note 3: Transmit mode control voltage logic: CTL1, CTL2, and CTL3 = 01xb (refer to Table 2).

Note 4: Parameter is characterized under the conditions listed in this Table, but is not production tested. Measurement performed with spectrum analyzer RBW = 100 kHz for frequencies < 1 GHz or RBW = 1 MHz for frequencies from 1 GHz to 10 GHz.

Table 10. SKY65346-21 Electrical Specifications: RFIO to TSW_TX Transmit Path (Note 1) (Note 2) (Note 3)
(VCC1 = VCC2 = VDD = 3.3 V, Tc = -40 to +85 °C, f= 928 MHz, CW Input, Unless Otherwise Noted)

Parameter	Symbol	Test Condition	Min	Typical	Max	Units
Loss	L _{TSW}			1.5	3.1	dB
1 dB Output Compression Point (Note 4)	OP1dB _{TSW}	1 dB gain compression		+20		dBm
3 rd Order Output Intercept Point	OIP3 _{TSW}	400 kHz spacing, P _{IN} = -10 dBm/tone	+27	+30		dBm
Input return loss	IS11 TSW			8.9		dB
Output return loss	IS22 TSW			11.5		dB

Note 1: Performance is guaranteed only under the conditions listed in this Table.

Note 2: Parameters are characterized under the conditions noted here and production tested under nominal temperature and voltage conditions with guard-banded limits.

Note 3: Transmit mode control voltage logic: CTL1, CTL2, and CTL3 = 01xb (refer to Table 2).

Note 4: Parameter is characterized under the conditions listed in this Table, but is not production tested.

Typical Performance Characteristics

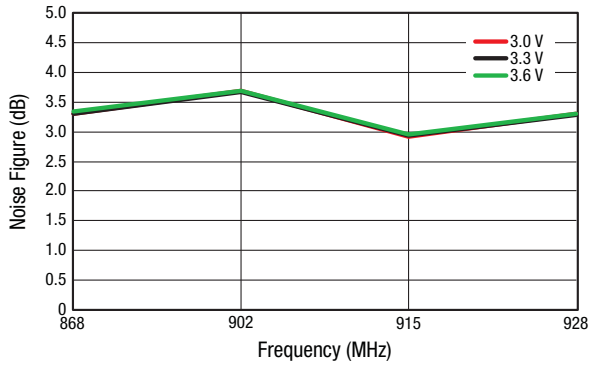

Figure 3. Transmit Path PA_IN to ANT1/ANT2 Noise Figure vs Frequency Over Supply Voltage

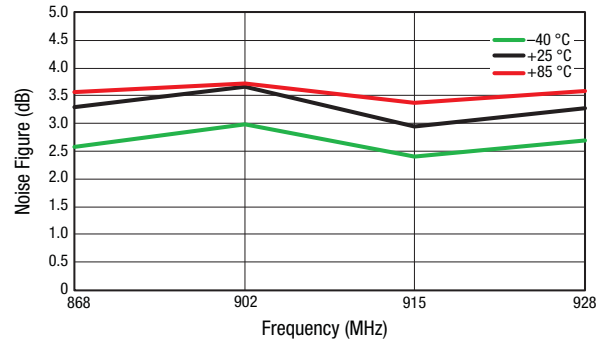

Figure 4. Transmit Path PA_IN to ANT1/ANT2 Noise Figure vs Frequency Over Temperature

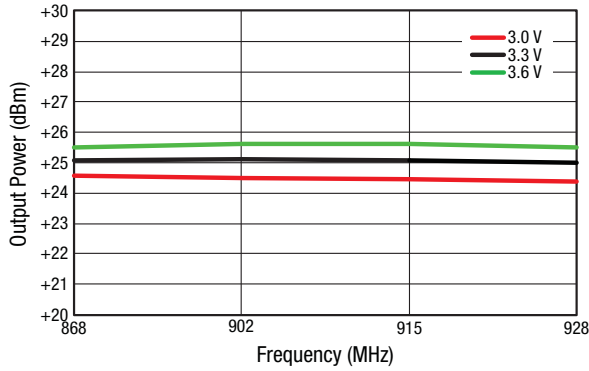

Figure 5. Transmit Path PA_IN to ANT1/ANT2 Output Power vs Frequency Over Supply Voltage

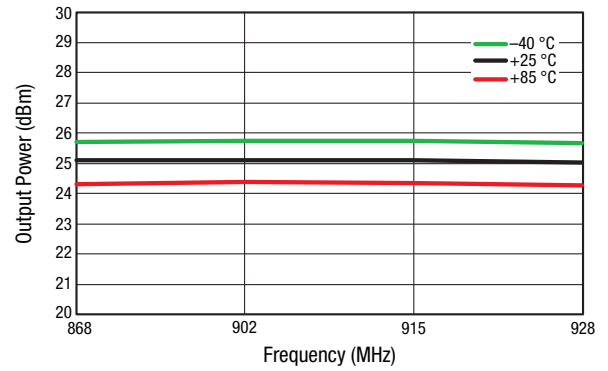

Figure 6. Transmit Path PA_IN to ANT1/ANT2 Output Power vs Frequency Over Temperature

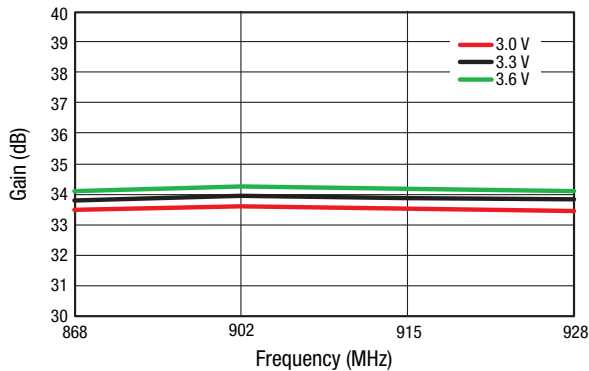

Figure 7. Transmit Path PA_IN to ANT1/ANT2 Gain vs Frequency Over Supply Voltage

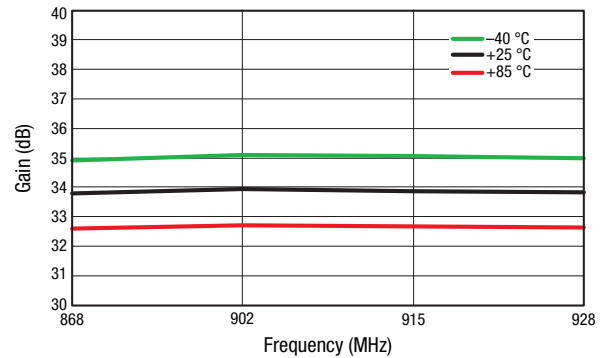

Figure 8. Transmit Path PA_IN to ANT1/ANT2 Gain vs Frequency Over Temperature

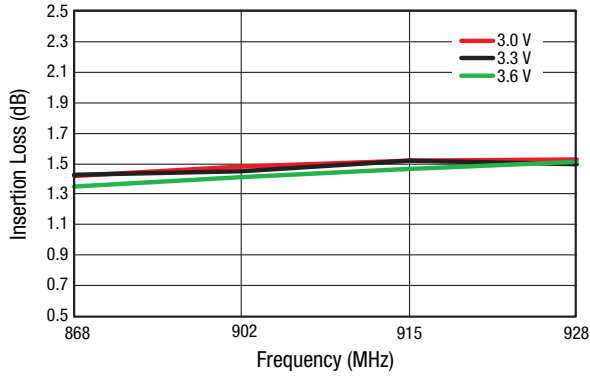

Figure 9. Transceiver Switch Insertion Loss (RFIO to TSW_TX) vs Frequency Over Supply Voltage

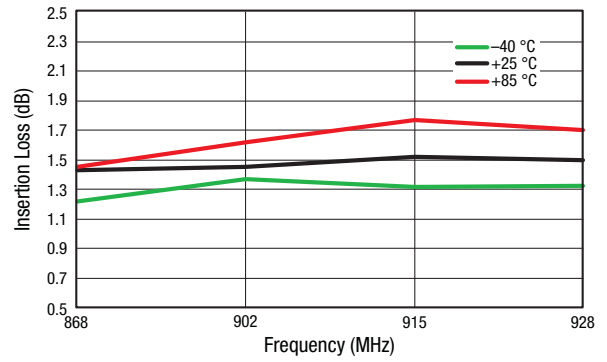

Figure 10. Transceiver Switch Insertion Loss (RFIO to TSW_TX) vs Frequency Over Temperature

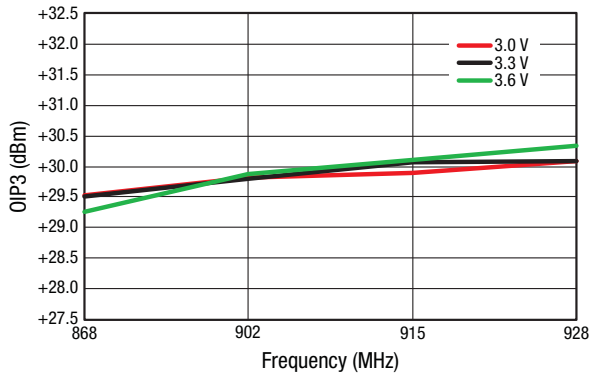

Figure 11. Transceiver Switch OIP3 (RFIO to TSW_TX) vs Frequency Over Supply Voltage

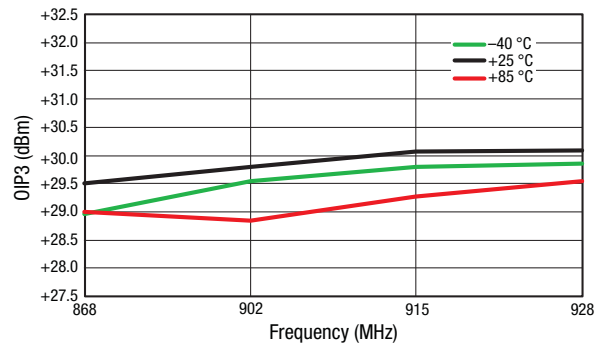

Figure 12. Transceiver Switch OIP3 (RFIO to TSW_TX) vs Frequency Over Temperature

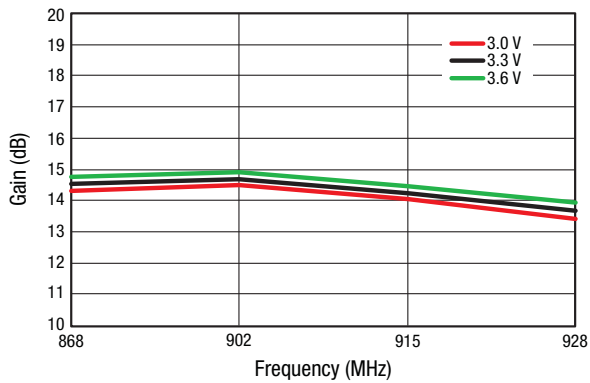

Figure 13. Receive Path Gain (LNA_IN to RFIO) vs Frequency Over Supply Voltage

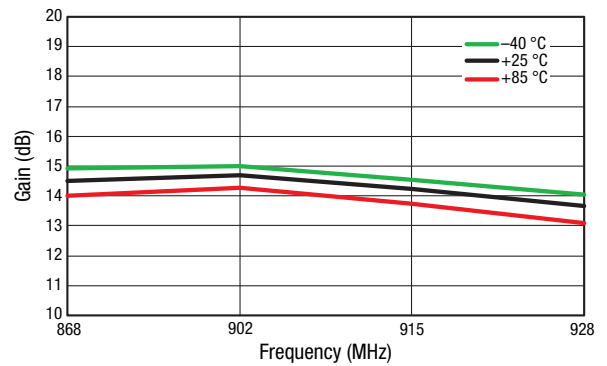

Figure 14. Receive Path Gain (LNA_IN to RFIO) vs Frequency Over Temperature

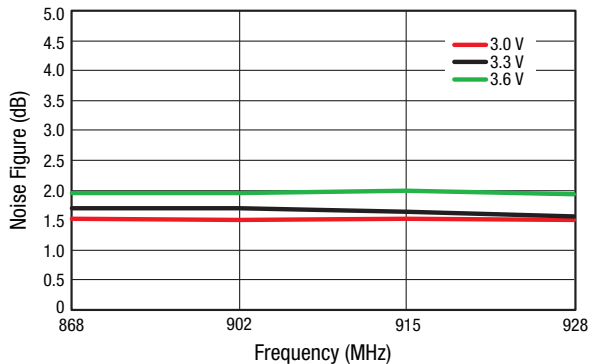

Figure 15. Receive Path Noise Figure (LNA_IN to RFIO) vs Frequency Over Supply Voltage

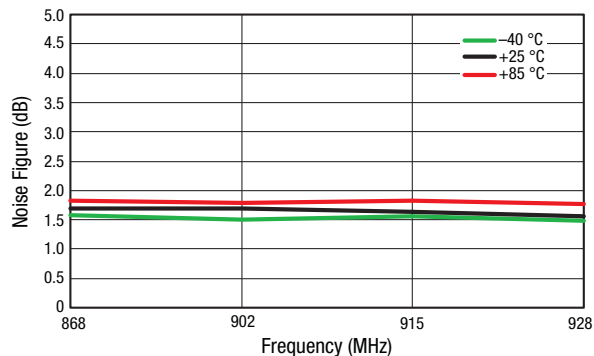

Figure 16. Receive Path Noise Figure (LNA_IN to RFIO) vs Frequency Over Temperature

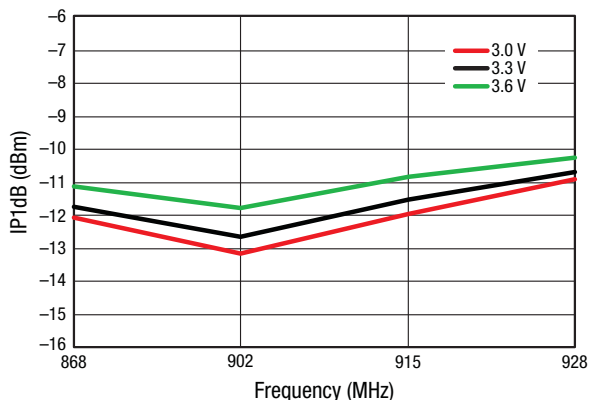

Figure 17. Receive Path IP1dB (LNA_IN to RFIO) vs Frequency Over Supply Voltage

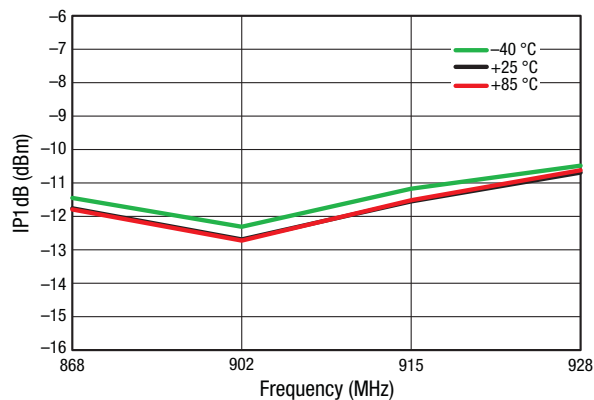

Figure 18. Receive Path IP1dB (LNA_IN to RFIO) vs Frequency Over Temperature

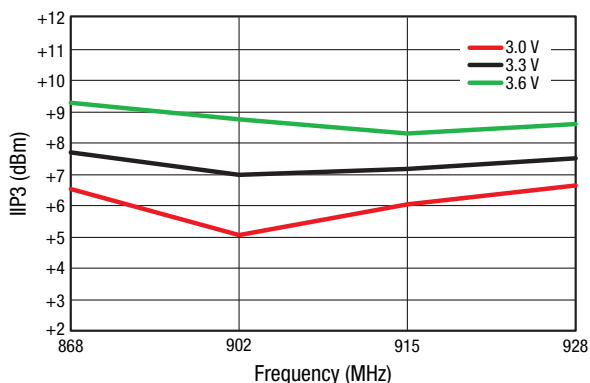

Figure 19. Receive Path IIP3 (LNA_IN to RFIO) vs Frequency Over Supply Voltage

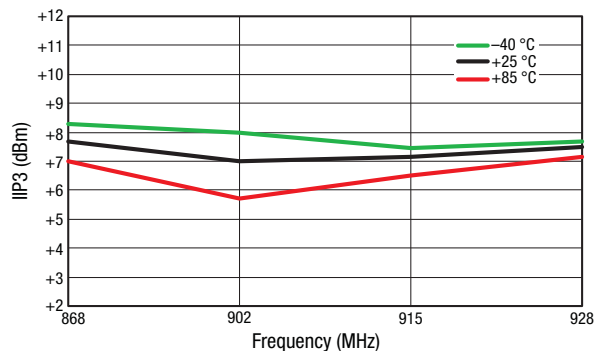

Figure 20. Receive Path IIP3 (LNA_IN to RFIO) vs Frequency Over Temperature

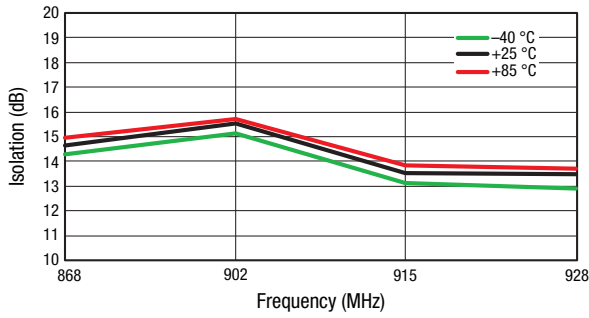

Figure 21. Receive Path Isolation (LNA_IN to TSW_TX) vs Frequency Over Temperature

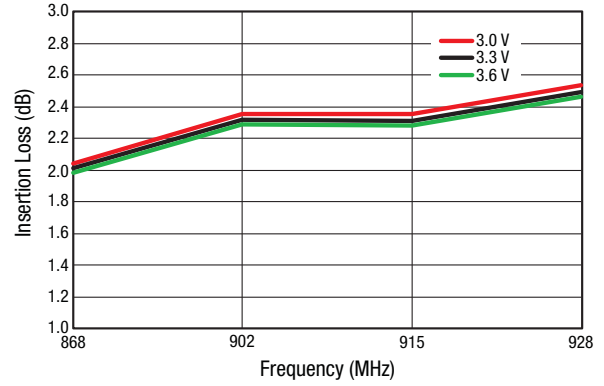

Figure 22. Receive Bypass Mode Insertion Loss (LNA_IN to RFIO) vs Frequency Over Supply Voltage

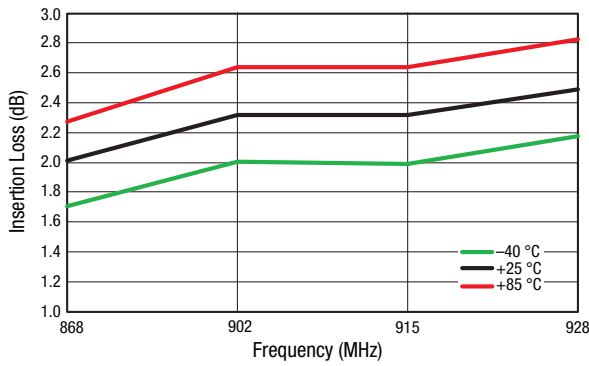

Figure 23. Receive Bypass Mode Insertion Loss (LNA_IN to RFIO) vs Frequency Over Temperature

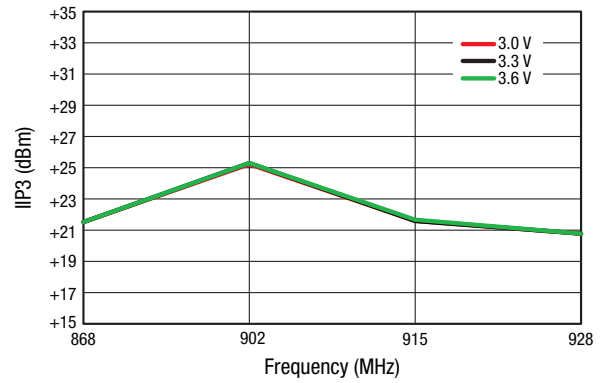

Figure 24. Receive Bypass Mode IIP3 (LNA_IN to RFIO) vs Frequency Over Supply Voltage

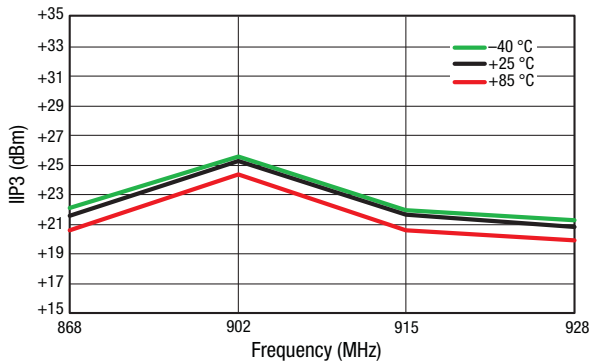

Figure 25. Receive Bypass Mode IIP3 (LNA_IN to RFIO) vs Frequency Over Temperature

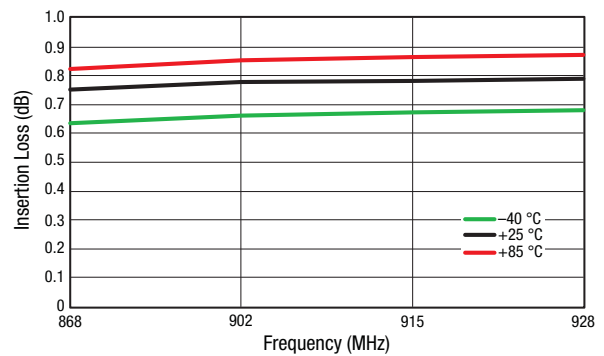

Figure 26. Receive Path Switch Loss (ANT1/ANT2 to ASW_RX) vs Frequency Over Temperature

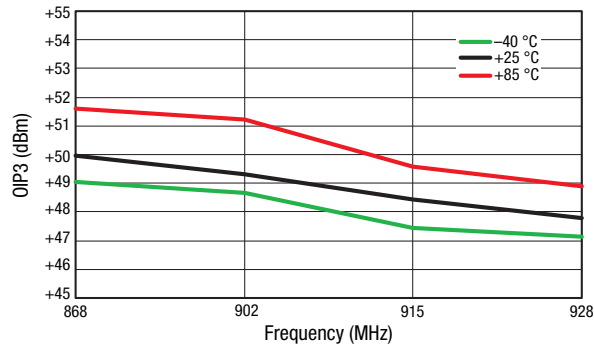

Figure 27. Receive Path OIP3 (ANT1/ANT2 to ASW_RX) vs Frequency Over Temperature

Evaluation Board Description

The SKY65346-21 Evaluation Board is used to test the performance of the SKY65346-21 FEM. An Evaluation Board schematic diagram is provided in Figure 28. An assembly drawing for the Evaluation Board is shown in Figure 29 and the layer detail is provided in Figure 30.

Circuit Design Configurations

The following design considerations are general in nature and must be followed regardless of final use or configuration:

1. Paths to ground should be made as short as possible.
2. The ground pads of the SKY65346-21 have special electrical and thermal grounding requirements. These pads are the main thermal conduit for heat dissipation. Since the circuit board acts as the heat sink, it must shunt as much heat as possible from the device. Therefore, design the connection to the ground pads to dissipate the maximum wattage produced by the circuit board. Multiple vias to the grounding layer are required.
3. Two external output bypass capacitors (10 nF and 100 pF) are required on pin 23 (VCC2). The same two capacitor values are also required on pin 9 (VCC1). The capacitors should be placed in parallel between the supply line and ground.
4. Pins 9 and 23 (VCC1 and VCC2, respectively) may be connected together at the supply.

NOTE: A poor connection between the slug and ground increases junction temperature (T_j), which reduces the lifetime of the device.

Package Dimensions

The PCB layout footprint for the SKY65346-21 is provided in Figure 31. Typical case markings are shown in Figure 32. Package dimensions for the 26-pin MCM are shown in Figure 33, and tape and reel dimensions and provided in Figure 34.

Package and Handling Information

Since the device package is sensitive to moisture absorption, it is baked and vacuum packed before shipping. Instructions on the shipping container label regarding exposure to moisture after the container seal is broken must be followed. Otherwise, problems related to moisture absorption may occur when the part is subjected to high temperature during solder assembly.

THE SKY65346-21 is rated to Moisture Sensitivity Level 3 (MSL3) at 260 °C. It can be used for lead or lead-free soldering. For additional information, refer to the Skyworks Application Note, *PCB Design & SMT Assembly/Rework Guidelines for MCM-L Packages*, document number 101752.

Care must be taken when attaching this product, whether it is done manually or in a production solder reflow environment. Production quantities of this product are shipped in a standard tape and reel format.

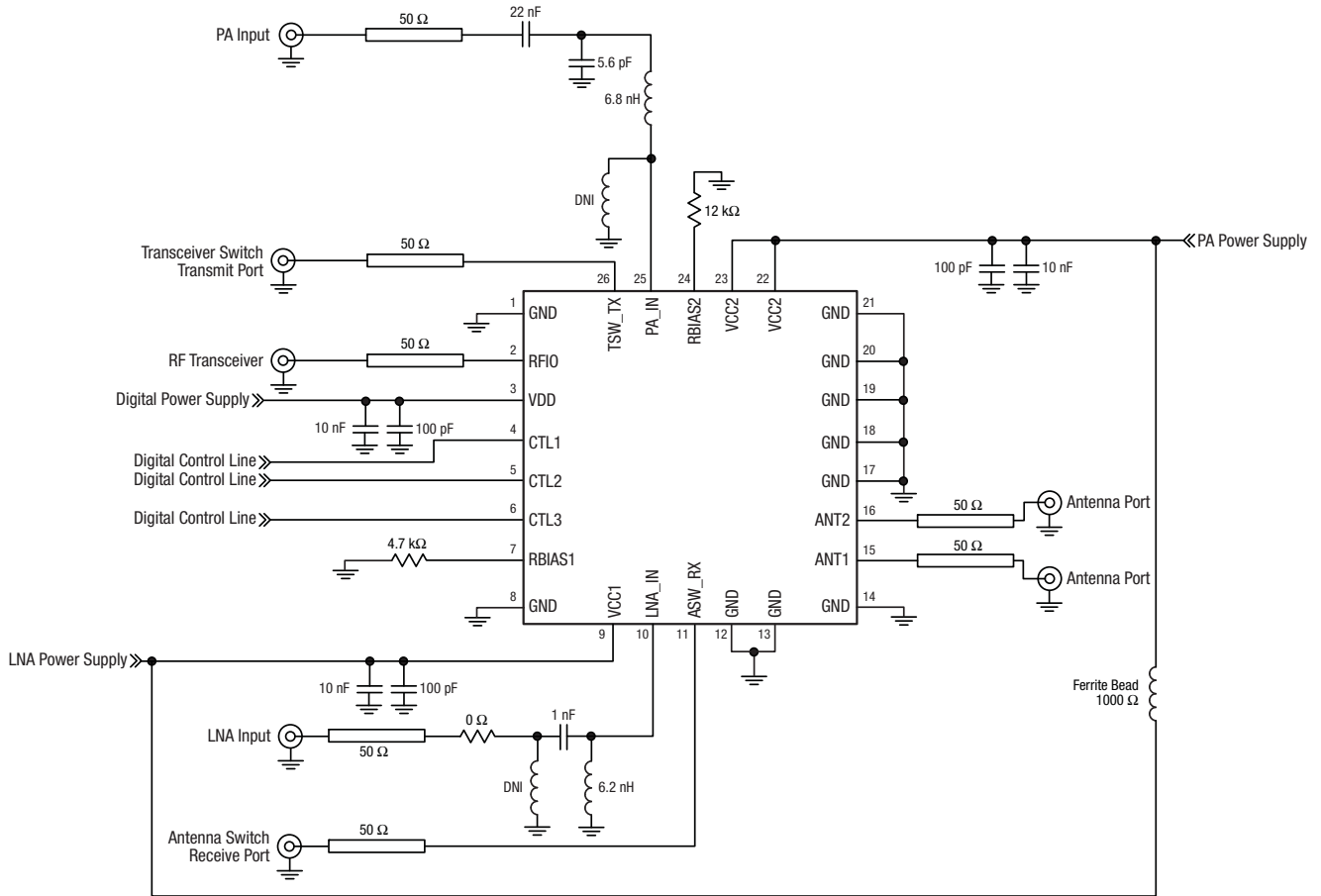

NOTE: The T-lines shown are a reminder to use 50 Ω traces.

S1771

Figure 28. SKY65346-21 Evaluation Board Schematic

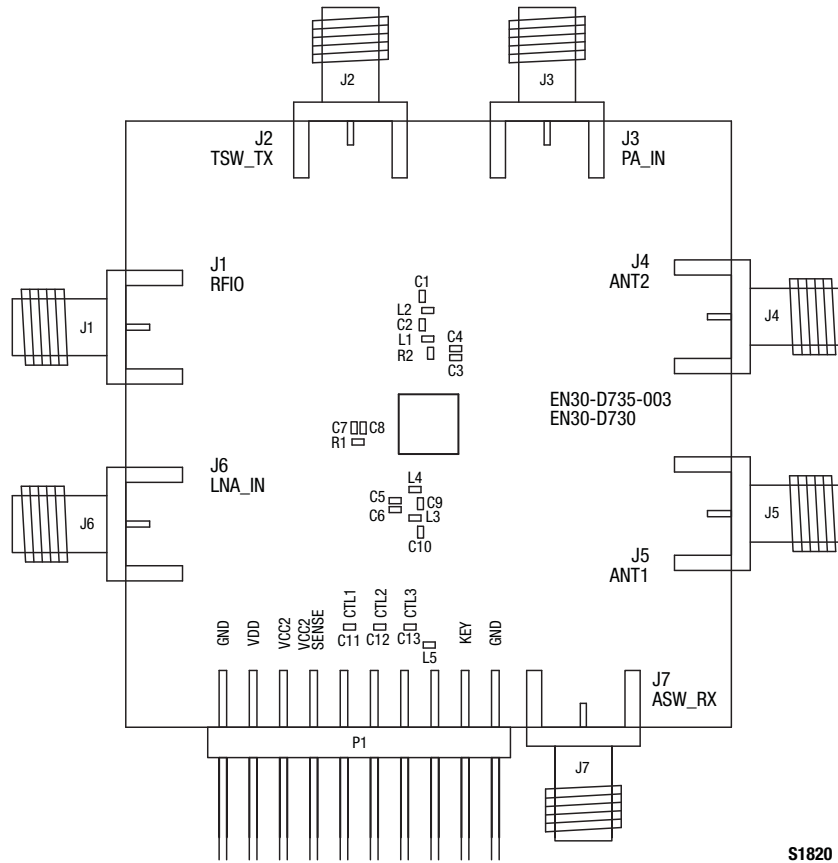

S1820

Figure 29. SKY65346-21 Evaluation Board Assembly Diagram

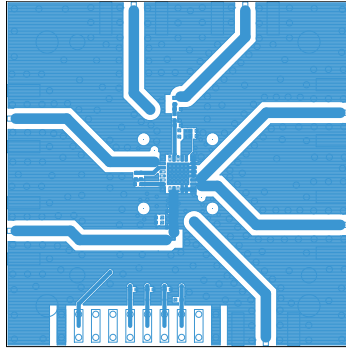

Layer 1: Top – Metal

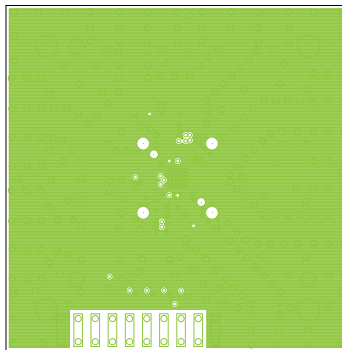

Layer 1: Solder Mask

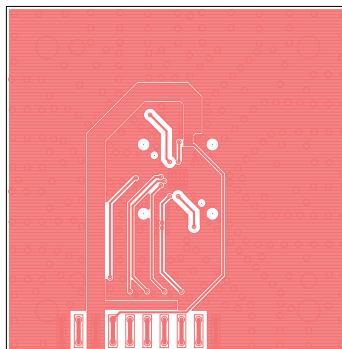

Layer 2: Ground

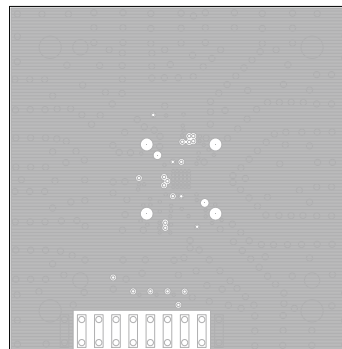

Layer 4: Solid Ground Plane

S1821

Figure 30. SKY65346-21 Evaluation Board Layer Detail

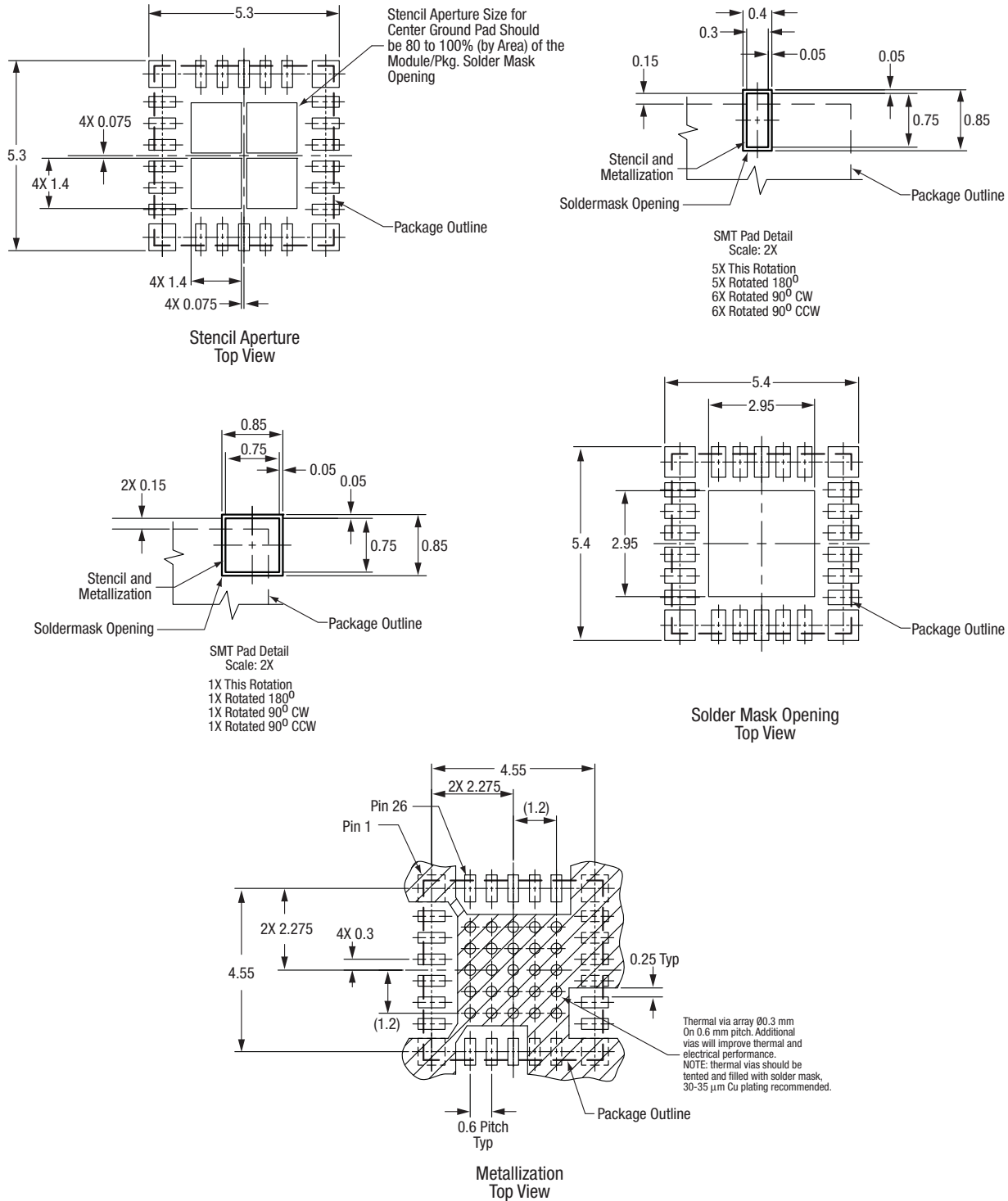

Note: The cross-hatched area represents the merger of the center ground pad + 10 individual I/O ground pads. All I/O ground pads should have at least one via connected to internal ground planes for optimum electrical performance.

All dimensions are in millimeters

S1822

Figure 31. SKY65346-21 PCB Layout Footprint

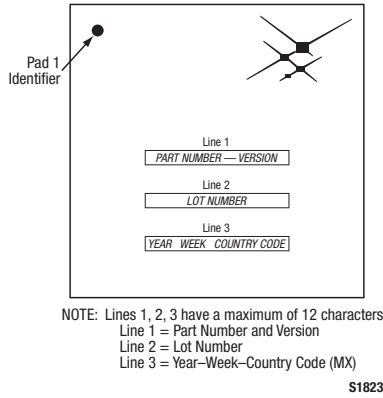
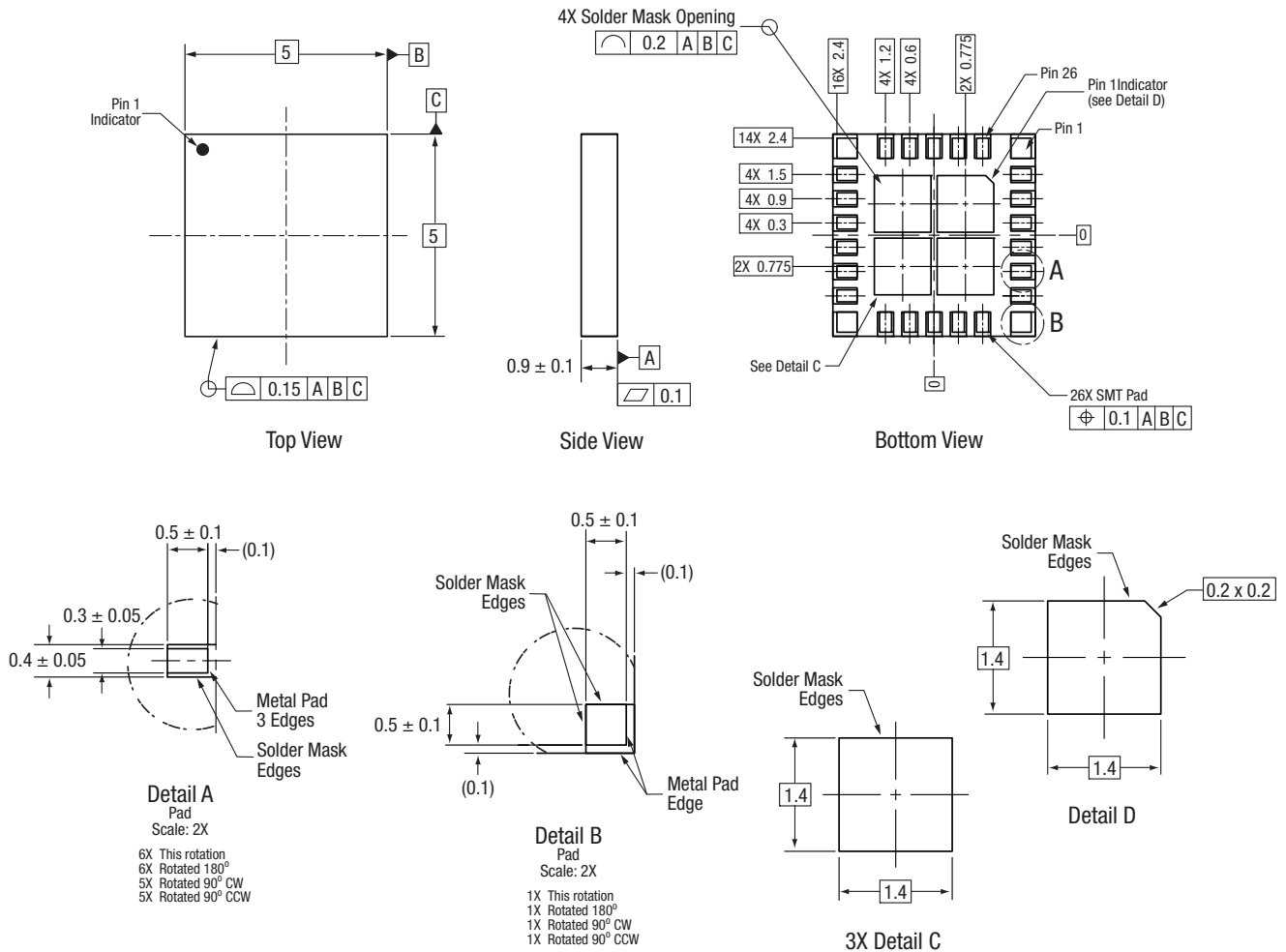

Figure 32. Typical Case Markings (Top View)



All measurements are in millimeters
Dimensioning and tolerancing according to ASME Y14.5M-1994

S1734

Figure 33. SKY65346-21 26-Pin MCM Package Dimensions

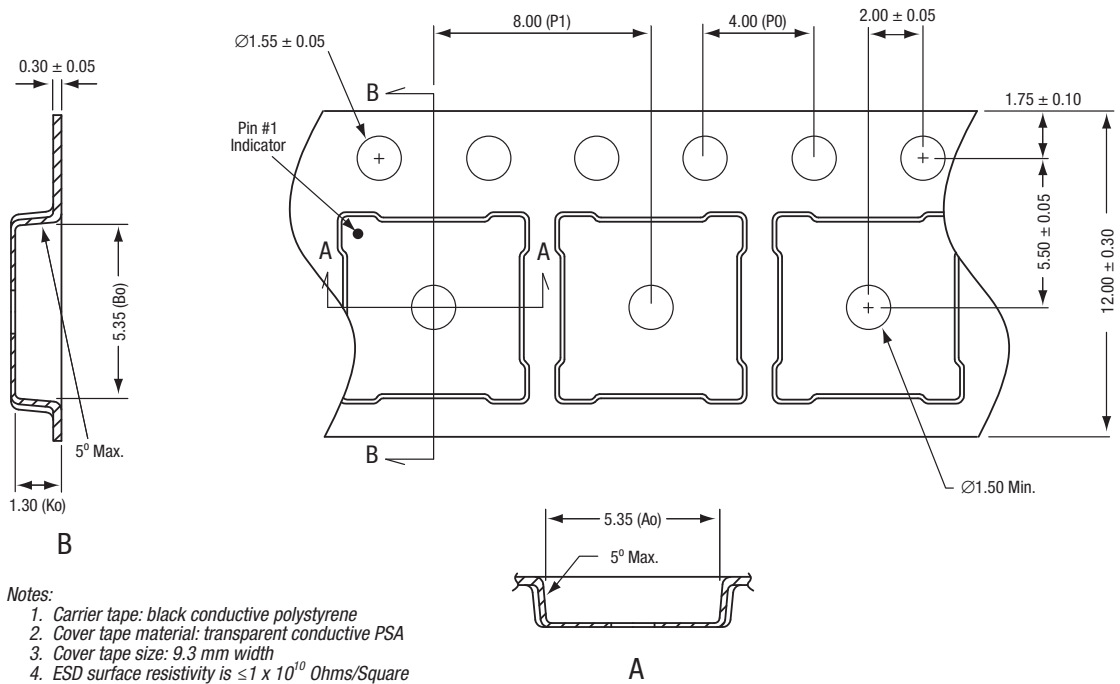

- Notes:
1. Carrier tape: black conductive polystyrene
 2. Cover tape material: transparent conductive PSA
 3. Cover tape size: 9.3 mm width
 4. ESD surface resistivity is $\leq 1 \times 10^{10}$ Ohms/Square according to EIA, JEDIC TNR specification.
 5. P₀/P₁ 10 pitches cumulative tolerance on tape: ± 0.20 mm
 6. A and B measurement points are 0.30 mm from bottom pocket.
 7. All dimensions are in millimeters

S461a

Figure 34. SKY65346-21 Tape and Reel Dimensions

Ordering Information

Model Name	Manufacturing Part Number	Evaluation Board Part Number
SKY65346-21 900 MHz T/R FEM	SKY65346-21	TW19-D960

Copyright © 2012 Skyworks Solutions, Inc. All Rights Reserved.

Information in this document is provided in connection with Skyworks Solutions, Inc. (“Skyworks”) products or services. These materials, including the information contained herein, are provided by Skyworks as a service to its customers and may be used for informational purposes only by the customer. Skyworks assumes no responsibility for errors or omissions in these materials or the information contained herein. Skyworks may change its documentation, products, services, specifications or product descriptions at any time, without notice. Skyworks makes no commitment to update the materials or information and shall have no responsibility whatsoever for conflicts, incompatibilities, or other difficulties arising from any future changes.

No license, whether express, implied, by estoppel or otherwise, is granted to any intellectual property rights by this document. Skyworks assumes no liability for any materials, products or information provided hereunder, including the sale, distribution, reproduction or use of Skyworks products, information or materials, except as may be provided in Skyworks Terms and Conditions of Sale.

THE MATERIALS, PRODUCTS AND INFORMATION ARE PROVIDED “AS IS” WITHOUT WARRANTY OF ANY KIND, WHETHER EXPRESS, IMPLIED, STATUTORY, OR OTHERWISE, INCLUDING FITNESS FOR A PARTICULAR PURPOSE OR USE, MERCHANTABILITY, PERFORMANCE, QUALITY OR NON-INFRINGEMENT OF ANY INTELLECTUAL PROPERTY RIGHT; ALL SUCH WARRANTIES ARE HEREBY EXPRESSLY DISCLAIMED. SKYWORKS DOES NOT WARRANT THE ACCURACY OR COMPLETENESS OF THE INFORMATION, TEXT, GRAPHICS OR OTHER ITEMS CONTAINED WITHIN THESE MATERIALS. SKYWORKS SHALL NOT BE LIABLE FOR ANY DAMAGES, INCLUDING BUT NOT LIMITED TO ANY SPECIAL, INDIRECT, INCIDENTAL, STATUTORY, OR CONSEQUENTIAL DAMAGES, INCLUDING WITHOUT LIMITATION, LOST REVENUES OR LOST PROFITS THAT MAY RESULT FROM THE USE OF THE MATERIALS OR INFORMATION, WHETHER OR NOT THE RECIPIENT OF MATERIALS HAS BEEN ADVISED OF THE POSSIBILITY OF SUCH DAMAGE.

Skyworks products are not intended for use in medical, lifesaving or life-sustaining applications, or other equipment in which the failure of the Skyworks products could lead to personal injury, death, physical or environmental damage. Skyworks customers using or selling Skyworks products for use in such applications do so at their own risk and agree to fully indemnify Skyworks for any damages resulting from such improper use or sale.

Customers are responsible for their products and applications using Skyworks products, which may deviate from published specifications as a result of design defects, errors, or operation of products outside of published parameters or design specifications. Customers should include design and operating safeguards to minimize these and other risks. Skyworks assumes no liability for applications assistance, customer product design, or damage to any equipment resulting from the use of Skyworks products outside of stated published specifications or parameters.

Skyworks, the Skyworks symbol, and “Breakthrough Simplicity” are trademarks or registered trademarks of Skyworks Solutions, Inc., in the United States and other countries. Third-party brands and names are for identification purposes only, and are the property of their respective owners. Additional information, including relevant terms and conditions, posted at www.skyworksinc.com, are incorporated by reference.